

## Accuride 3832 front disconnect drawer runners, full extension

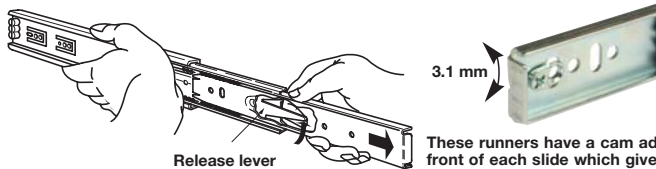

Release lever

These runners have a cam adjuster on the front of each slide which gives 3.1 mm adjustment on the drawer front

The correct side space dimension is critical for the runner to work. You must allow between +0.2mm and +0.5mm over the runner thickness.

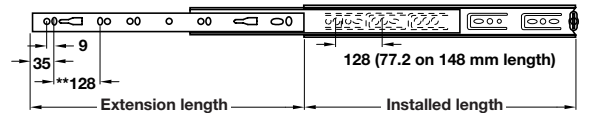
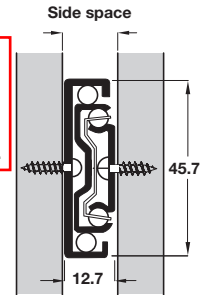

\*hole not available on 150-300 mm lengths  
\*\*dim. 96 mm on 150-300 mm lengths



Optional brackets for bottom or shelf mounting of these runners are available, see page 242 for details

- > Side mounting
- > For applications such as filing cabinets, desk pedestals and general storage drawers
- > Load carrying capacity up to 50 kg (see below for individual runner capacity)
- > Front disconnect (by depressing lever) for drawer removal
- > Hold-in feature holds the closed drawer in. Hold-out feature holds the drawer in the open position
- > 32 mm drilling pattern
- > Tolerance absorption tabs
- > Improved retainer retention device
- > Grooved cabinet member, for better movement
- > Zinc-plated steel
- > \*Corrosion resistant for harsh environments, 8 times more protection than regular zinc finishes, stainless steel ball retainer, ball bearings and rivets
- > Order fixing screws separately (max. head height 2.5 mm, Ø 9.6 mm)
- > Order qty: 1 pair



Installed length	Extension length	Load capacity	Bright	White	Black	*Corr. resistant
<b>Accuride 3832, with Hold-in feature</b>		Tested cycles 80,000				
148 mm	138 mm	45 kg	422.41.915	422.41.715	422.41.315	-
199 mm	203 mm	46 kg	422.41.920	422.41.720	422.41.320	-
250 mm	254 mm	47 kg	422.41.925	422.41.725	422.41.325	-
300 mm	305 mm	48 kg	422.41.930	422.41.730	422.41.330	422.41.830
350 mm	356 mm	49 kg	422.41.935	422.41.735	422.41.335	422.41.835
400 mm	406 mm	50 kg	422.41.940	422.41.740	422.41.340	422.41.840
450 mm	457 mm	50 kg	422.41.945	422.41.745	422.41.345	422.41.845
500 mm	508 mm	50 kg	422.41.950	422.41.750	422.41.350	422.41.850
550 mm	559 mm	50 kg	422.41.955	422.41.755	422.41.355	422.41.855
600 mm	610 mm	50 kg	422.41.960	422.41.760	422.41.360	422.41.860
650 mm	660 mm	49 kg	422.41.965	422.41.765	422.41.365	-
700 mm	711 mm	48 kg	422.41.970	422.41.770	422.41.370	-
<b>Accuride 3832DO Hold-out feature</b>		Tested cycles 80,000 (10,000)				
300 mm	305 mm	42 kg (48 kg)	422.91.931			
350 mm	356 mm	43 kg (49 kg)	422.91.936			
400 mm	406 mm	44 kg (50 kg)	422.91.941			
450 mm	457 mm	45 kg (50 kg)	422.91.946			
500 mm	508 mm	45 kg (50 kg)	422.91.951			
550 mm	559 mm	45 kg (50 kg)	422.91.956			
600 mm	610 mm	45 kg (50 kg)	422.91.961			
650 mm	660 mm	44 kg (49 kg)	422.91.966			

TCH TECHNOLOGY 2018, © Häfele U.K. Ltd 2018. Dimensional data not binding. We reserve the right to alter specifications without notice.

PAGE AMENDED  
25.02.19/1

Approved by Product Info. Dept.

SALES DEPARTMENT 0800 171 2909 TECHNICAL SUPPORT 0800 171 2908

Accuride 3832 front disconnect drawer runners, full extension

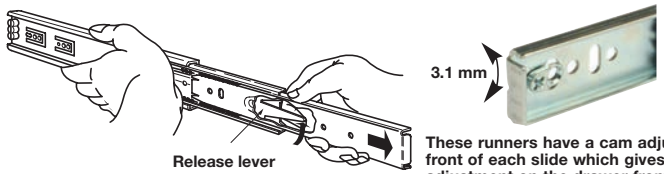

Release lever  
These runners have a cam adjuster on the front of each slide which gives 3.1 mm adjustment on the drawer front

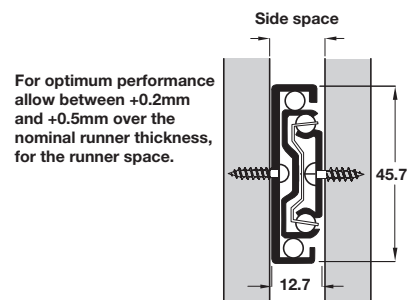

For optimum performance allow between +0.2mm and +0.5mm over the nominal runner thickness, for the runner space.

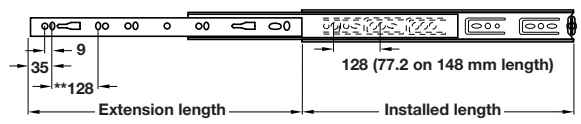

\*hole not available on 150-300 mm lengths  
\*\*dim. 96 mm on 150-300 mm lengths

Optional brackets for bottom or shelf mounting of these runners are available on page 242 for details

- > Side mounting
- > For applications such as filing cabinets, desk pedestals and general storage drawers
- > Load carrying capacity up to 50 kg (see below for individual runner capacity)
- > Front disconnect (by depressing lever) for drawer removal
- > Hold-in feature holds the closed drawer in. Hold-out feature holds the drawer in the open position
- > 32 mm drilling pattern
- > Tolerance absorption tabs
- > Improved retainer retention device
- > Grooved cabinet member, for better movement
- > Zinc-plated steel
- > \*Corrosion resistant for harsh environments, 8 times more protection than regular zinc finishes, stainless steel ball retainer, ball bearings and rivets
- > Order fixing screws separately (max. head height 2.5 mm, 9)
- > Order qty: 1 pair

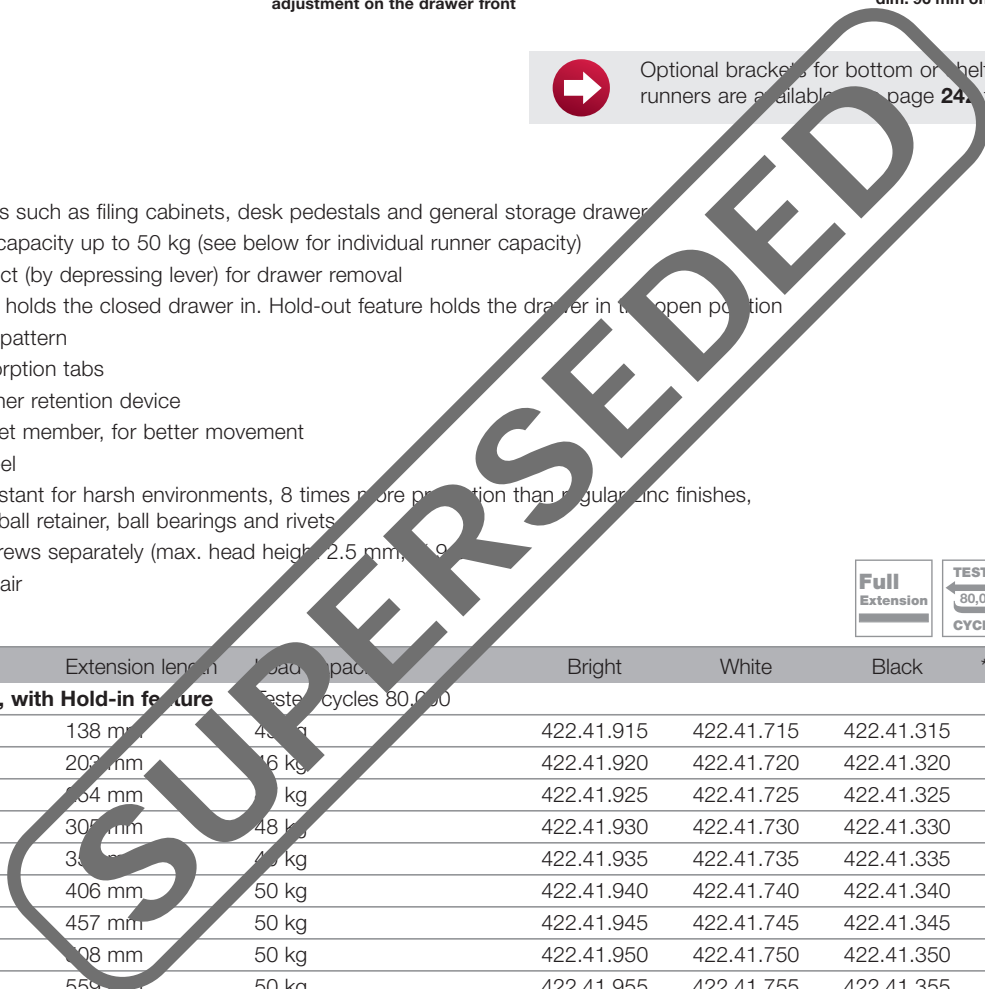

Full Extension  
TESTED 80,000 CYCLES  
FIXINGS REQUIRED VARIANTA Ø 5  
FIXINGS REQUIRED HÖSPA Ø 4.0

Installed length	Extension length	Load capacity	Bright	White	Black	*Corr. resistant
<b>Accuride 3832, with Hold-in feature</b>		Tested cycles 80,000				
148 mm	138 mm	43 kg	422.41.915	422.41.715	422.41.315	-
199 mm	200 mm	46 kg	422.41.920	422.41.720	422.41.320	-
250 mm	264 mm	47 kg	422.41.925	422.41.725	422.41.325	-
300 mm	305 mm	48 kg	422.41.930	422.41.730	422.41.330	422.41.830
350 mm	356 mm	49 kg	422.41.935	422.41.735	422.41.335	422.41.835
400 mm	406 mm	50 kg	422.41.940	422.41.740	422.41.340	422.41.840
450 mm	457 mm	50 kg	422.41.945	422.41.745	422.41.345	422.41.845
500 mm	508 mm	50 kg	422.41.950	422.41.750	422.41.350	422.41.850
550 mm	559 mm	50 kg	422.41.955	422.41.755	422.41.355	422.41.855
600 mm	610 mm	50 kg	422.41.960	422.41.760	422.41.360	422.41.860
650 mm	660 mm	49 kg	422.41.965	422.41.765	422.41.365	-
700 mm	711 mm	48 kg	422.41.970	422.41.770	422.41.370	-
<b>Accuride 3832DO Hold-out feature</b>		Tested cycles 80,000 (10,000)				
300 mm	305 mm	42 kg (48 kg)	422.91.931			
350 mm	356 mm	43 kg (49 kg)	422.91.936			
400 mm	406 mm	44 kg (50 kg)	422.91.941			
450 mm	457 mm	45 kg (50 kg)	422.91.946			
500 mm	508 mm	45 kg (50 kg)	422.91.951			
550 mm	559 mm	45 kg (50 kg)	422.91.956			
600 mm	610 mm	45 kg (50 kg)	422.91.961			
650 mm	660 mm	44 kg (49 kg)	422.91.966			

TCH TECHNOLOGY 2018, © Häfele U.K. Ltd 2018. Dimensional data not binding. We reserve the right to alter specifications without notice.