

HAWA-JUNIOR 40/Z AND 40/B SLIDING DOOR SYSTEM

Junior 40/Z is a vertically adjustable sliding door fitting for light to medium weight interior doors, for top quality joinery and partitioning. HAWA-Junior 40/B is suitable for low and restricted headroom applications.

Sliding Door Fittings for Architectural Applications: Sliding Interior Doors

- > HAWA-Junior 40/Z
- > Range:
 - Max. door weight **40 kg**
 - Min. door thickness **22 mm**
- > Height adjustment ± 3 mm
- > Installation drawing reference 17689

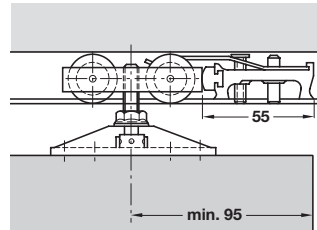
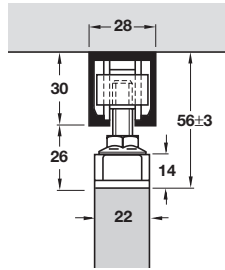
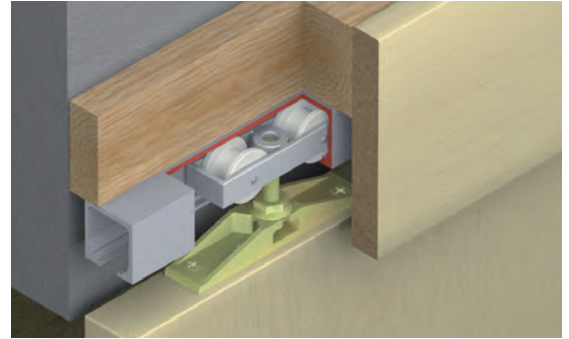

Easy to install

The two-way mounting plate allows the sliding door to be taken off or suspended in two different ways:

- Fig. 1 - Side mounting
- Fig. 2 - Front mounting

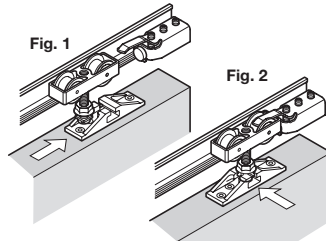

- > HAWA-Junior 40/B
- > For low and restricted headroom applications
- > Range:
 - Max. door weight **40 kg**
 - Min. door thickness **30 mm**
 - Max. door height normally **2.1 m**
- > Height adjustment ± 3 mm
- > Installation drawing reference 17689

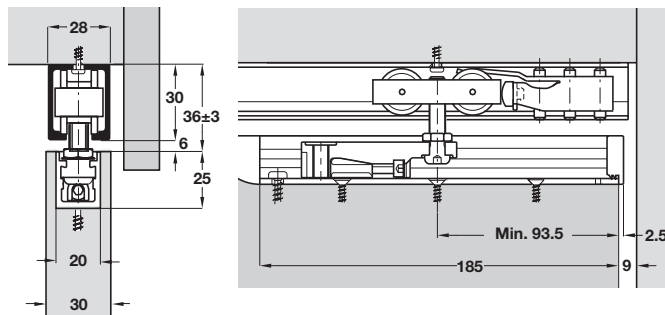
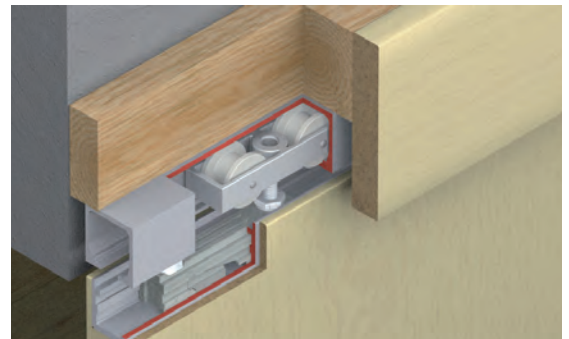

Complete sets for 1 door shown below or tracks and fitting sets available to order separately, shown on page 43

Hawa-Junior 40/Z and 40/B complete sets

HAWA-Junior 40/B sets include a side fixing profile, track fixing set and profile trim caps for side fixing, refer to page 51 for details

- > HAWA-Junior 40/Z and 40/B sets include 1x 2.0 m length track and all fittings required for 1 door, including 1 additional track stopper
- > Order qty: 1 set

Complete fitting set for 1 door	Junior 40/Z	Junior 40/B
Cat. No.	940.40.010	940.40.011

TCB AH 2019, © Häfele U.K. Ltd 2019. Dimensional data not binding. We reserve the right to alter specifications without notice.

HAWA-Junior 40 tracks

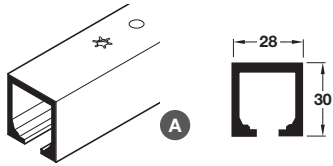

- > With screw holes for soffit fixing
- > Two top tracks are mounted side by side for double or multiple doors
- > Silver anodised aluminium
- > Order qty: 1 pc



Top track side fixing profile is available, shown on page 43

Length	2.0 m	3.0 m
Cat. No.	940.40.200	940.40.300

HAWA-Junior 40/Z and 40/B fitting sets

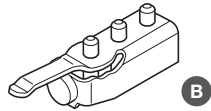

Track stopper positioned in top track

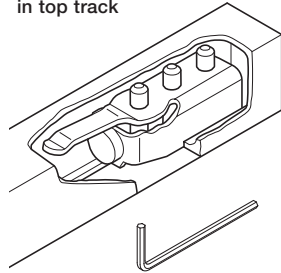

The retaining force can be adjusted with an allen key

- > Fitting sets, for one door
- B Track stopper, 18 x 59 x 21 mm, for adjustable mounting in top track, zinc alloy housing, adjustable retaining force
- C HAWA-Junior 40/Z trolley hanger, sleeve bearing mounted Ø 25 mm high-grade polyamide tandem rollers, aluminium carriage with zinc-alloy mounting plate, fixings included
- D HAWA-Junior 40/B trolley hanger, sleeve bearing mounted Ø 25 mm high-grade polyamide tandem rollers, with 25 x 185 x 20 mm retainer profile and suspension plate, M8 hanger pendant and tension bolt, fixings included
- E Locking wrench, for suspension profile
- F Profile plugs, grey plastic
- G Guide, rattle proof, for screw mounting to floor, black plastic, 24 x 60 x 34 mm
- > Order qty: 1 set

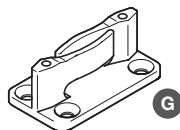
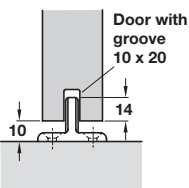
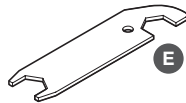
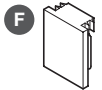
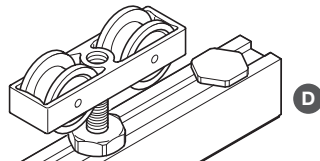
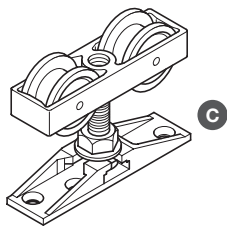

Fitting set for 1 door	Junior 40/Z	Junior 40/B
B Track stopper	2 pcs	2 pcs
C Junior 40 trolley hanger	2 pcs	-
D Junior 40/B trolley hanger	-	2 pcs
E Locking wrench	-	1 pc
F Profile plugs	-	2 pcs
G Guide	1 pc	1 pc
Cat. No.	940.41.016	940.41.017
Additional items		
Item B		940.40.041
Item G		940.40.031

HAWA-Junior alternative light duty guiding with continuous aluminium channel

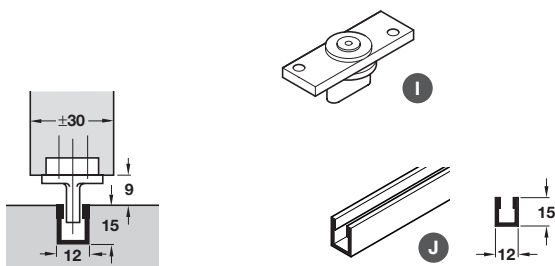

- > For HAWA-Junior 40/80
- > Recommended for doors over 1000 mm wide
- I Guide, steel plate with nylon blade, 25 x 60 x 23.5 mm, 2 pcs required per door
- J Channel, pre-drilled for counter sunk screws, bright aluminium
- > Order qty: 1 pc

Guide		
Item I		409.12.990
Channel	2.1 m	3.0 m
Item J	409.14.010	409.14.029